

P510 SERIES

0 TO 5 OR 10 VDC ANALOG OUTPUT



0 to 5 or 0 to 10 VDC output

The UniMeasure P510 series position transducer provides a 0 to 5 or 0 to 10 VDC output utilizing a potentiometric sensor. Pins B and C of the connector are both COMMON and are connected together internally at the transducer enabling a three or four wire connection. With adjustable zero and span, zero position may be set within the first 30% of the total measurement range. The span allows maximum output voltage to be adjusted to 5 VDC or 10 VDC for displacements between 80% and 100% of total range. The P510 may be powered by an unregulated supply voltage in the range of 4.9 to 30 VDC.

SPECIFICATIONS

General

Linearity	
2", 3", 4" & 5" Ranges	±0.30% Full Scale
10", 15", 20" & 25" Ranges	±0.20% Full Scale
All other ranges	±0.15% Full Scale
Repeatability ¹	±0.015% Full Scale
Resolution	Essentially Infinite
Construction	Aluminum Cover & Baseplate
Sensing Device	Precision Potentiometer
Connector	MS3102A-14S-6P
Wire Rope	Ø.016 Stainless Steel
Wire Rope Tension	See Supplemental Data ³ , Table 7
Wire Rope Inbound Acceleration	See Supplemental Data ³ , Table 7
Weight	1.0 lb. (0.45 Kg) to 50"
	1.4 lb. (0.63 Kg) 60" & 80"
Dimensional Information	See Supplemental Data ³ , Fig. 1 & 2
Options and Accessories	See Supplemental Data ³

Environmental

Operating temperature	-40°C to +85°C
Storage Temperature	-55° to +100°C
Operating humidity	90% R.H. max. non-condensing
Vibration	15 G's 0.1 ms max.
Shock	50 G's 0.1 ms max.
Ingress Protection	NEMA 1, IP-40

Electrical

Output	0 to 5 VDC adjustable to 10 VDC
Excitation Voltage	4.9 to 30 VDC
Excitation Current	25 mA max.
Output Impedance	10Ω max.
Output Load	5KΩ min.
Insulation resistance	100 megohms min. at 100 VDC
Zero Adjustment Range	0 to 30% of Range
Span Adjustment Range ²	80% to 100% of Range
Protection	Reversed Polarity
Temperature Stability	.02%/°C of Span

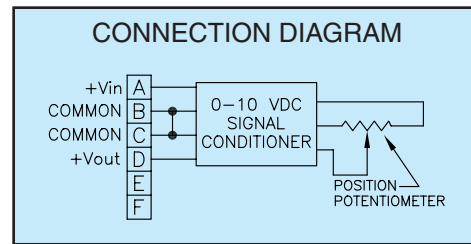

FOOTNOTES TO SPECIFICATIONS

- Moving to the same position from the same direction.
- Span may be adjusted from 5 VDC to 10 VDC within percentage of range shown.
- Supplemental Data section located at end of Standard Series pages.

Model Number Configuration

P510- - - - -

Range	
2	2" (50 mm)
3	3" (75 mm)
4	4" (100 mm)
5	5" (125 mm)
10	10" (250 mm)
15	15" (390 mm)
20	20" (500 mm)
25	25" (640 mm)
30	30" (750 mm)
40	40" (1000 mm)
50	50" (1250 mm)
60	60" (1500 mm)
80	80" (2000 mm)

Wire Rope	
*	Ø.016 (0,4 mm) Stainless Steel
NJC	Ø.018 (0,45 mm) Nylon Jacketed Stainless Steel

Wire Rope Tension	
*	Standard (50 G units to 50")
004	Reduced (see Table 7 for value)
HG	Increased (100G on units with ranges from 2" to 50")

Wire Rope Exit Direction	
*	Top Exit
CES	Side Exit
CEB	Bottom Exit

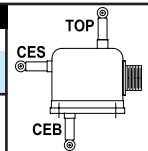

Dust Wiper Option	
*	No dust wiper
DS	Dust Wiper Installed

Electrical Interface	
*	Mating Connector Included
TS	Terminal Strip
L3M	Mating Conn with 3 m (10') electrical cable
L4M	Mating Conn with 4 m (13.5') electrical cable
L5M	Mating Conn with 5 m (16.5') electrical cable
L6M	Mating Conn with 6 m (20') electrical cable
L7M	Mating Conn with 7 m (23') electrical cable

Connector Location	
*	Standard Location
S3	Rear Side

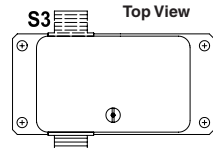

Electrical Output Polarity	
*	Standard (increasing output as wire rope is extended)
R	Reversed (decreasing output as wire rope is extended)

NOTE

- *—Asterisk items are standard configuration. No option designator is required.
- Shaded options available at additional cost.
- See Supplemental Data for options.

Example
P510-50-NJC-CEB-TS

ADDITIONAL OPTIONS

OPTION	OPTION DESIGNATOR	DESCRIPTION
Nylon jacketed wire rope	NJC	Replaces standard stainless steel wire rope with Ø.018 nylon jacketed wire rope. Increases wire rope life dramatically but may increase non-linearity by as much as ±0.05% of full scale.
Reduced Wire Rope Tension	004	Reduces the overall tension in the wire rope and increases wire rope life. Dynamic response of the transducer is reduced due to the reduced inbound acceleration capability.
Increased Wire Rope Tension	HG	Increases tension in the wire rope which increases the dynamic response of the transducer. On selected units with range of 50" (1250 mm) or less, inbound acceleration capability is 100G's. Wire rope life may be adversely affected by the HG option.
Dust wiper	DS	Lubricated wiper strips dust and debris from wire rope as it retracts into case. Adds 0.36" (9 mm) height to wire rope exit location.
Terminal strip	TS	Replaces connector with a terminal strip.
Reversed output	R	Output is at a maximum when wire rope is fully retracted. Output decreases as wire rope is extended. Does not apply to velocity signal.
Non-standard potentiometer (applies to PA series only)	PXK	Replace "X" in option designator with required potentiometer value in K ohms. Non-standard potentiometer linearity is as follows: Ranges 0 to 2" to 0 to 5" ±1.00% of full scale Ranges 0 to 10" to 0 to 25" ±0.50% of full scale Ranges 30" and above ±0.25% of full scale Note: This option is subject to potentiometer availability.

ACCESSORIES

10067 Auxiliary Wire Rope Extension Kit

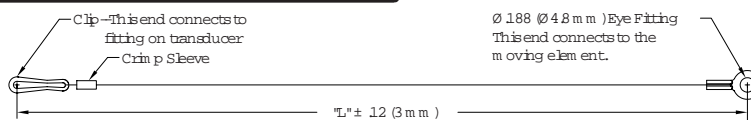

The auxiliary wire rope extension may be used to facilitate mounting the transducer remotely from the measurement point. The clip on the extension attaches to the eye fitting on the transducer. The eye fitting on the opposite end which is identical to the fitting on the transducer mounts to the moving element. The extension kit is also available with the clip end unterminated for situations where it is more convenient to size the wire rope length during installation. The clip and crimp sleeve are included as loose parts for user termination.

Dimension "L"

Specify dimension "L" in centimeters to the **nearest whole centimeter**.

Note 1. 1 cm = 0.394", 1 inch = 2.54 cm

Note 2. Shortest length "L" is 5 cm (approximately 2").

10067- CM-

* Completed kit (no designator required)

U Unterminated clip end
(clip and crimp sleeve included in kit)

* Leave blank. No designator required.

Replacement Wire Rope Kit

The replacement Wire Rope Kit includes a new wire rope with all end terminations, wire rope guide, felt dust wiper where applicable and installation instructions. To order, replace 'xx' in the part number with the applicable measurement range in inches.

10107-xx Replacement Wire Rope Kit—Standard Ø.016" stainless steel wire rope.

10108-xx Replacement Wire Rope Kit—NJC option, Ø.018" nylon jacketed stainless steel wire rope.

10127-xx Replacement Wire Rope Kit—DS option, Standard Ø.016" stainless steel wire rope with dust wiper.

10128-xx Replacement Wire Rope Kit—NJC and DS options, Ø.018" nylon jacketed stainless steel wire rope with dust wiper.

ADDITIONAL SPECIFICATIONS

TABLE 7

PA, PB, P420, P510, P1010 SERIES						EP Series			V & VP Series					
Range Designator	Range		Wire Rope Standard Tension		Wire Rope Standard Acceleration	Wire Rope Reduced Tension		Wire Rope Reduced Acceleration	Wire Rope Reduced Tension		Wire Rope Reduced Acceleration			
	(in)	(mm)	(Nominal)	(G's)	(004 option)	(004 option)	(G's)	(004 option)	(004 option)	(G's)				
	(oz)	(N)			(oz)	(N)		(oz)	(N)					
2	2	50	34	9.5	>50	16	4.4	28	—	—	16	4.4	14	
3	3	75	24	6.7	>50	14	3.9	16	—	—	14	3.9	15	
4	4	100	24	6.7	>50	11	3.1	12	—	—	11	3.1	15	
5	5	125	34	9.5	>50	8	2.2	7	—	—	8	2.2	6	
10	10	250	34	9.5	>50	16	4.4	28	16	4.4	19	16	4.4	14
15	15	390	24	6.7	>50	14	3.9	16	—	—	14	3.9	15	
20	20	500	24	6.7	>50	11	3.1	12	—	—	11	3.1	14	
25	25	640	34	9.5	>50	8	2.2	7	8	2.2	7	8	2.2	6
30	30	750	24	6.7	>50	14	3.9	16	—	—	14	3.9	15	
40	40	1000	24	6.7	>50	11	3.1	12	—	—	11	3.1	12	
50	50	1250	34	9.5	>50	8	2.2	7	8	2.2	7	8	2.2	5
60	60	1500	24	6.7	27	7	1.8	2	7	1.8	5	7	1.8	6
80	80	2000	19	5.3	16	5	1.4	2	5	1.4	2	5	1.4	3

DIMENSIONAL INFORMATION

PA, PB, P420, P510, P1010, EP & V Series

RANGES TO 50" (1250 mm)

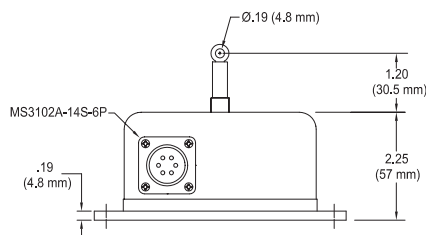
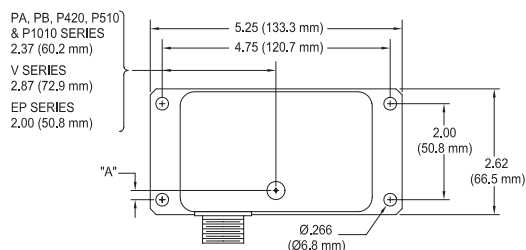

Figure 1

RANGES TO 60" (1500 mm) and 80" (2000 mm)

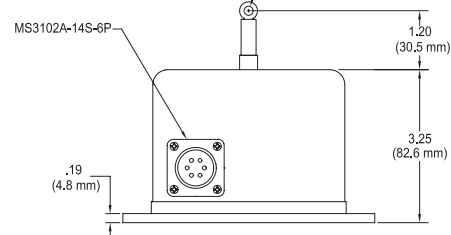
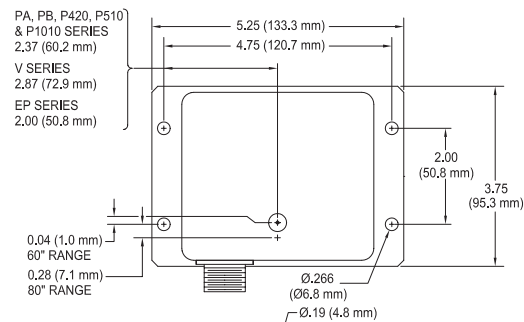

Figure 2

RANGE	"A" (mm)	
2", 10"	0.66	16.8
3", 15", 30"	0.51	12.9
4", 20", 40"	0.35	8.8
5", 25", 50"	0.19	4.8
60"	See Figure 2	
80"	See Figure 2	

MODEL	"A" (mm)	
EP-10	0.68	17.4
EP-25, EP-50	0.21	5.3
EP-60	See Figure 2	
EP-80	See Figure 2	
EPM-250	0.68	17.4
EPM-1250	0.21	5.3